

Dell™ PowerVault™ 770N NAS Systems User's Guide

[System Overview](#)

[Using the System Setup Program](#)

[Technical Specifications](#)

[I/O Ports and Connectors](#)

[Using Console Redirection](#)

[Glossary](#)



NOTE: A NOTE indicates important information that helps you make better use of your computer.



NOTICE: A NOTICE indicates either potential damage to hardware or loss of data and tells you how to avoid the problem.



CAUTION: A CAUTION indicates a potential for property damage, personal injury, or death.

Model SCL

Information in this document is subject to change without notice.

© 2002 Dell Computer Corporation. All rights reserved.

Reproduction in any manner whatsoever without the written permission of Dell Computer Corporation is strictly forbidden.

Trademarks used in this text: *Dell*, the *DELL* logo, *PowerEdge*, *PowerVault*, and *Dell OpenManage* are trademarks of Dell Computer Corporation; *Intel* and *Pentium* are registered trademarks and *Intel386* and *Xeon* are trademarks of Intel Corporation; *Microsoft*, *MS-DOS*, *Windows NT*, and *Windows* are registered trademarks of Microsoft Corporation; *UNIX* is a registered trademark of The Open Group in the United States and other countries.

Other trademarks and trade names may be used in this document to refer to either the entities claiming the marks and names or their products. Dell Computer Corporation disclaims any proprietary interest in trademarks and trade names other than its own.

Initial Release: 25 Jun 2002

System Overview

Dell™ PowerVault™ 770N NAS Systems User's Guide

- [System Orientation](#)
- [System-Status Indicators](#)
- [Front-Panel Features](#)
- [Back-Panel Features](#)
- [System Features](#)
- [Supported Operating Systems](#)
- [Power Protection Devices](#)
- [Other Documents You May Need](#)
- [Obtaining Technical Assistance](#)

Your Dell™ PowerVault™ 770N NAS system provides optimized file-serving capabilities on a robust rackmount or tower platform. The base configuration features one Intel® Xeon™ microprocessor with 512 MB of memory. The maximum configuration includes two Xeon microprocessors with up to six memory modules.

This section describes the major hardware and software features of your system and provides information about the system status indicators, and indicators on the system's front panel. It also provides information about other documents you may need when setting up your system and how to obtain technical assistance.

System Orientation

When following the procedures in this guide, assume that the locations or directions relative to the system are as shown in [Figure 1-1](#). The illustrations in this document depict the tower version of the system lying on its side.

Figure 1-1. System Orientation

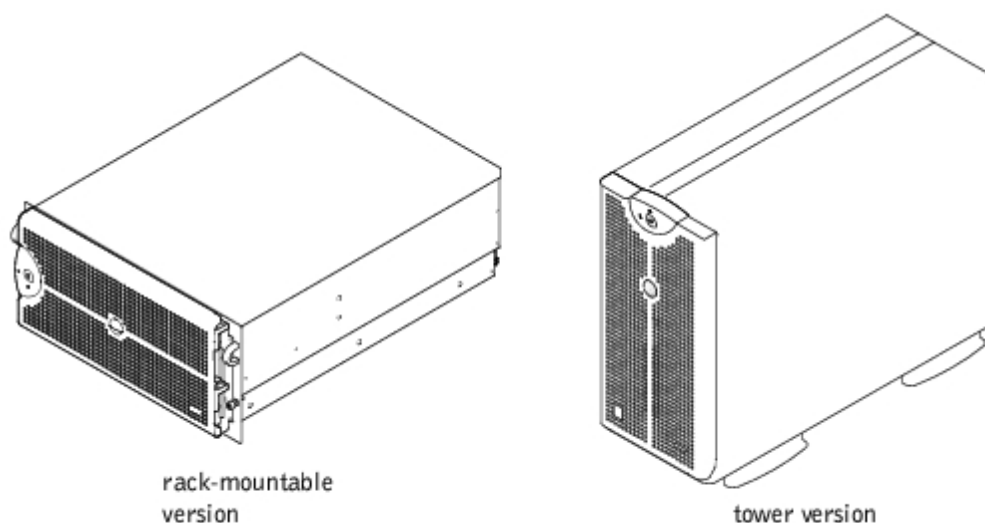

System-Status Indicators

The system has indicators that can represent system status. When the bezel is installed, the bezel system-status indicator (see [Figure 1-2](#)) signifies when the system is operating properly, or when the system needs attention. A caution code signifies a problem with microprocessors, power supply, system or power-supply fans, system temperature, hard drives, system

memory, expansion cards, or the integrated SCSI controller. When the bezel is off, the system-status indicators on the system (see [Figure 1-3](#)) assume the same functions as the bezel system-status indicator.

[Table 1-1](#) lists the system's status indicator codes.

Figure 1-2. Bezel System-Status Indicator

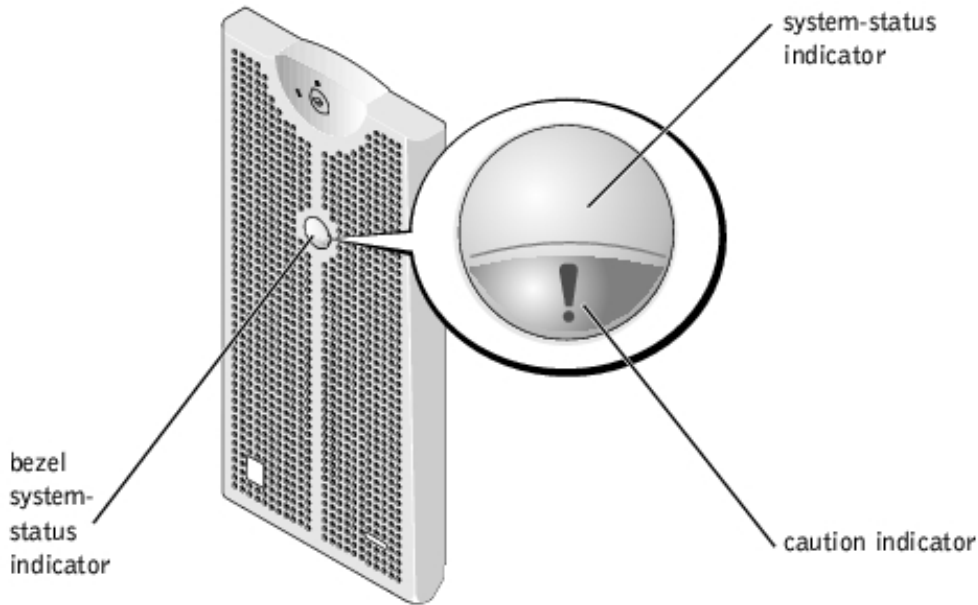

Table 1-1. System-Status Indicator Codes

System-Status Indicator	Caution Indicator	Indicator Code
Off	Off	No power is available to the system, or the system is not powered on.
On	Off	The system is operating normally.
Off	Blinking	The system has detected an error and requires attention.
Blinking	Off	The system is identifying itself.
Blinking	Blinking or Off	Systems management software causes the status indicator to blink to identify a particular system.

Front-Panel Features

Additional indicators for system power and drives are located behind the bezel.

[Figure 1-3](#) shows the front-panel features of the system. [Table 1-2](#) describes the front-panel features.

Figure 1-3. Front-Panel Features

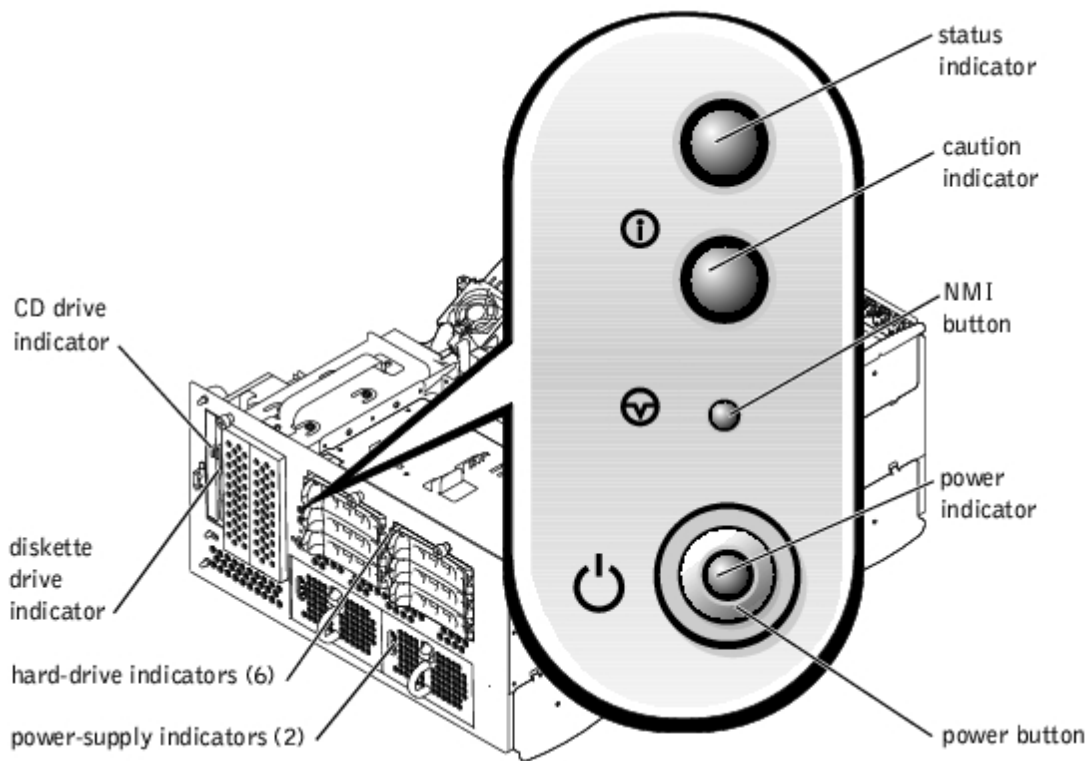

Table 1-2. Front-Panel Features

Component	Description
Power button	Turns system power off and on. If you turn off the system using the power button, the system can perform an orderly shutdown before power is turned off. The button is enabled in the System Setup program. When disabled, the button can only turn on system power.
Power indicators	Provides information about power status (see " Power Indicator ").
Power-supply indicators	Provides information about power status (see Table 1-4).
Status indicator	Provides information about when the system is operating properly, or when the system needs attention (see Table 1-1).
Caution indicator	Provides information about when the system is operating properly, or when the system needs attention (see Table 1-1).
CD and diskette drive indicators	Indicates read or write access to the respective drive.
Hard-drive status indicators	Provides information about the status of the respective hard drive (see Table 1-5).
NMI button	Troubleshoots software and device driver errors when using certain operating systems. You can press this button using the end of a paper clip. The NMI option is enabled in the System Setup program. ➔ NOTICE: Use the NMI button only if directed to do so by qualified support personnel or by the operating system's documentation. Pressing this button halts the operating system and displays a diagnostic screen.

Power Indicator

The system has indicators on the front panel and the power supplies that denote system power status (see [Figure 1-3](#)).

Power-Button Indicator Codes

The power button controls the power input to the system's power supplies. The power-button indicator can provide information on power status.

[Table 1-3](#) lists the power-button indicator codes.

Table 1-3. Power-Button Indicator Codes

Indicator	Indicator Code
On	Indicates that power is supplied to the system, and the system is operational.
Off	Indicates that no power is supplied to the system.
Blinking	Indicates that power is supplied to the system, but the system is in a standby state. For more information on standby states, see your operating system documentation.

Power-Supply Indicators

Each hot-pluggable power supply has indicators that provide information on power status, fault, and the presence of power (see [Figure 1-4](#)). [Table 1-4](#) lists the power-supply indicator codes.

Figure 1-4. Power-Supply Indicators

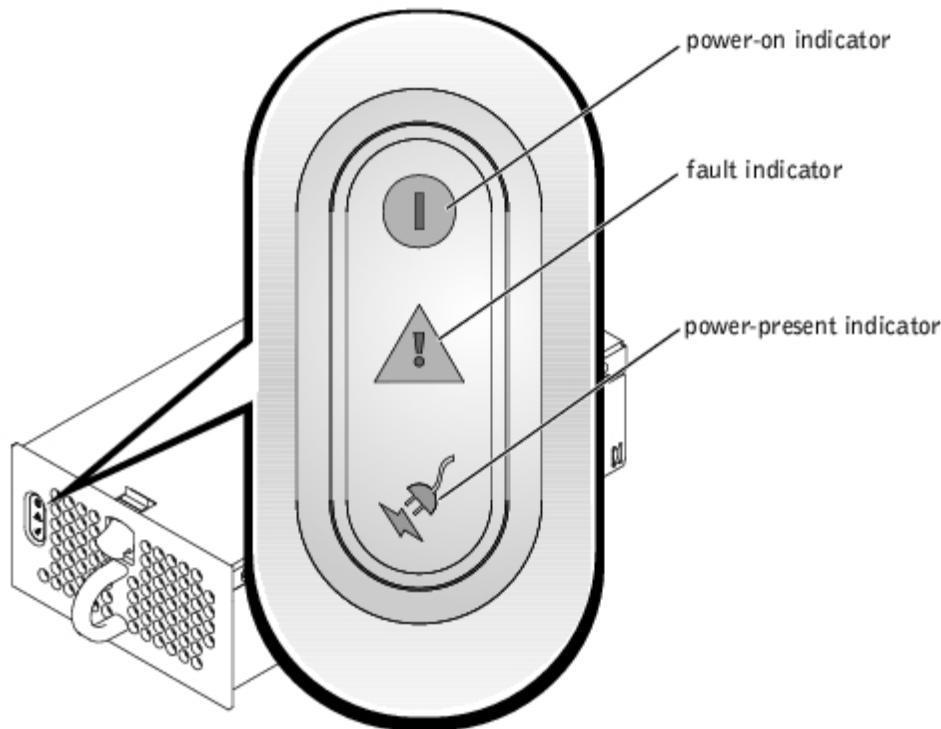

Table 1-4. Power-Supply Indicator Codes

Indicator	Indicator Code
-----------	----------------

Power-on	Green indicates that the power supply is operational.
Fault	Red indicates a problem with the power supply (such as a fan failure or voltage error).
Power present	Green indicates that power is present at the power supply and that the system is connected to a power source.

Hard-Drive Indicators

Each hard-drive carrier has two indicators: a drive-busy indicator and a drive-status indicator (see [Figure 1-5](#)). The indicators provide information on the status of the respective hard drive. [Table 1-5](#) lists the hard-drive status indicator codes.

Figure 1-5. Hard-Drive Status Indicators

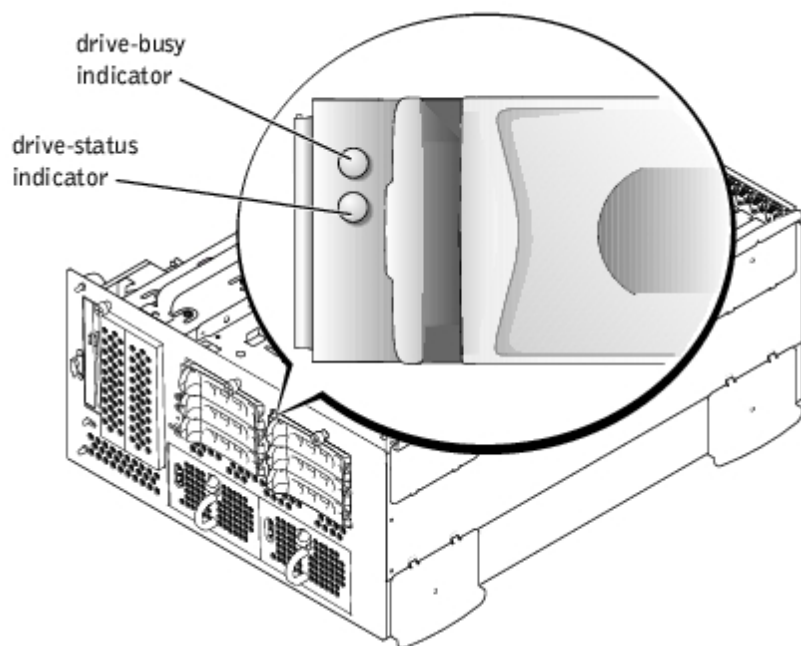

Different codes display as drive events occur in the system. For example, in the event of a hard-drive failure, the "drive fail" code appears. After the drive is selected for removal, the "prepared for removal" code appears. After the replacement drive is installed, the "prepared for operation, drive online" code appears.

Table 1-5. Hard-Drive Status Indicator Codes

Indicator	Indicator Code
Drive bay empty, ready for insertion or removal	Off
Drive being prepared for operation, drive online	Steady green
Identify drive	Blinks green four times per second
Drive being prepared for removal	Blinks green twice per second at equal intervals
Drive rebuilding	Blinks green twice per second at unequal intervals
Drive failed	Blinks amber four times per second
Predicted failure for the drive	Blinks green, then amber, and then off, repeating this sequence every two seconds
Drive online	Steady green

NOTE: The "drive busy" indicator signifies whether the hard drive is active on the SCSI bus. This indicator is controlled by the hard drive.

Back-Panel Features

Figure 1-6 shows the back-panel features of the system. For specific information about the back-panel connectors, see "[I/O Ports and Connectors](#)."

Figure 1-6. Back-Panel Features

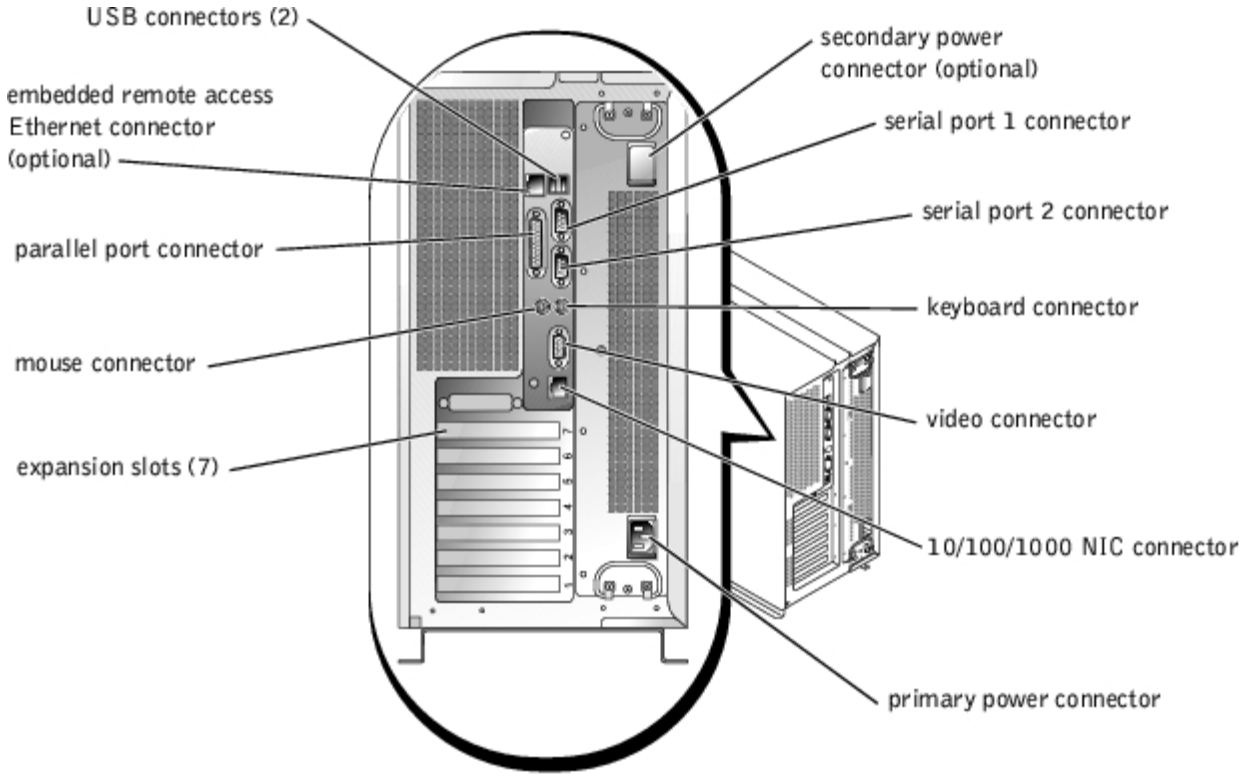

NIC Indicator

The NIC indicator on the back panel provides information on network activity and link status for the NIC (see [Figure 1-7](#)). [Table 1-6](#) lists the NIC indicator codes.

Figure 1-7. NIC Indicators

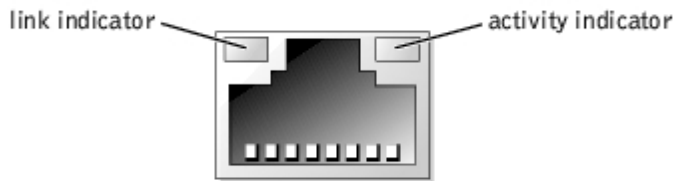

Table 1-6. NIC Indicator Codes

Link Indicator	Activity Indicator	Indicator Code
Off	Off	The NIC is not connected to the network.
Green	Off	The NIC is connected to a valid link partner on the network.
Green	Amber blinking	Network data is being sent or received.

Embedded Remote Access Ethernet Connector Indicators (Optional)

The embedded remote access Ethernet connector indicators on the back panel provide information on network activity and link status for the embedded remote access Ethernet connector (see [Figure 1-8](#)). [Table 1-7](#) lists the embedded remote access Ethernet connector indicator codes.

Figure 1-8. Embedded Remote Access Ethernet Connector

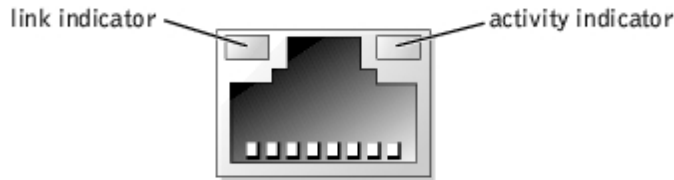

Table 1-7. Embedded Remote Access Ethernet Connector Indicator Codes

Link Indicator	Activity Indicator	Indicator Code
Off	Off	The NIC is not connected to the network.
Green	Amber	The NIC is connected to a valid link partner on the network.
Green	Amber blinking	Network data is being sent or received.

System Features

- One or two Intel Xeon microprocessors with 512 KB cache.
- SMP, which is available on systems with two Xeon microprocessors. SMP greatly improves overall system performance by dividing microprocessor operations between independent microprocessors.
- A minimum of 512 MB of system memory. To add additional system memory, install identical pairs of DDR SDRAM DIMMs in the six DIMM sockets on the system board.
- Support for up to eight 1-inch, internal Ultra320 or Ultra160 SCSI hard drives.
- Support for two additional hard drives in the system's media bay.
- Support for RAID levels 0, 1, 5, and 10.
- Two external 5.25-inch drive bays and a single dedicated 1.44-MB, 3.5-inch diskette drive.
- An IDE CD drive.
- Up to two hot-pluggable, 730-W power supplies with optional 1 + 1 redundant configuration.
- Five hot-pluggable system cooling fans.
- An intrusion switch that signals the appropriate systems management software if the bezel is removed.

System Board Features

- Six 64-bit PCI/PCI-X slots and one 32-bit PCI slot. Slots accept full-length cards designed for 133 MHz, 100 MHz, 66 MHz, or 33 MHz.

- An integrated VGA-compatible video subsystem with an ATI RAGE XL video controller. This video subsystem contains 8 MB of SDRAM video memory (nonupgradable). Maximum resolution is 1600 x 1200 x 16.7 million colors (noninterlaced).
- An integrated, dual-channel Ultra320 SCSI host adapter.
- Optional 1 x 2 backplane automatically configures the ID numbers and termination on individual hard drives, greatly simplifying drive installation.
- One integrated 10/100/1000 NIC, which provides an Ethernet interface.
- Embedded systems management circuitry that monitors operation of the system fans as well as critical system voltages and temperatures. The systems management circuitry works in conjunction with your systems management software.
- Back-panel connectors including video, keyboard, mouse, two serial, two USB, one NIC, and one optional embedded remote access Ethernet connector.

For more information about specific features, see "Technical Specifications."

Supported Operating Systems

Your system supports the Microsoft® Windows® Powered operating system.

Power Protection Devices

Certain devices protect your system from the effects of problems such as power surges and power failures.

- PDU — Uses circuit breakers to ensure that the AC current load does not exceed the PDU's rating.
 - Surge protector — Prevents voltage spikes, such as those that may occur during an electrical storm, from entering the system through the electrical outlet. They do not protect against brownouts, which occur when the voltage drops more than 20 percent below the normal AC line voltage level.
 - Line conditioner — Maintains a system's AC power source voltage at a moderately constant level and provides protection from brownouts, but does not protect against a complete power loss.
 - UPS — Uses battery power to keep the system running when AC power is unavailable. The battery is charged by AC power while it is available so that after AC power is lost, the battery can provide power to the system for a limited amount of time—from 15 minutes to approximately an hour. A UPS that provides only 5 minutes of battery power allows you to shutdown the system. Use surge protectors and PDUs with all universal power supplies, and ensure that the UPS is UL-safety approved.
-

Other Documents You May Need



The *System Information Guide* provides important safety and regulatory information. Warranty information may be included within this document or as a separate document.

- The *Rack Installation Guide* included with your rack solution describes how to install your system into a rack.
- The *Setting Up Your System* document provides an overview of initially setting up your system.
- The *Installation and Troubleshooting Guide* describes how to troubleshoot the system and install or replace system components.
- The *System Administrator's Guide* provides system configuration, operation, and management information.
- Systems management software documentation describes the features, requirements, installation, and basic operation of the software.

- Operating system documentation describes how to install (if necessary), configure, and use the operating system software.
- Documentation for any components you purchased separately provides information to configure and install these options.
- Updates are sometimes included with the system to describe changes to the system, software, and/or documentation.



NOTE: Always read the updates first because they often supersede information in other documents.

- Release notes or readme files may be included to provide last-minute updates to the system or documentation, or advanced technical reference material intended for experienced users or technicians.

Obtaining Technical Assistance

If you do not understand a procedure in this guide or if the system does not perform as expected, see your *Installation and Troubleshooting Guide*.

Dell Enterprise Training and Certification is available now; see www.dell.com/training for more information. This service may not be offered in all locations.

[Back to Contents Page](#)

Using the System Setup Program

Dell™ PowerVault™ 770N NAS Systems User's Guide

- [Entering the System Setup Program](#)
- [System Setup Options](#)
- [Using the System Password Feature](#)
- [Using the Setup Password Feature](#)
- [Disabling a Forgotten Password](#)

Each time you turn on your system, the system compares the configuration of the hardware installed in the system to the hardware listed in the system configuration information stored in NVRAM on the system board. If the system detects a discrepancy, it generates error messages that identify the incorrect configuration settings. The system then prompts you to enter the System Setup program to correct the settings.

You can use the System Setup program as follows:

- To change the system configuration information after you add, change, or remove any hardware in your system
- To set or change user-selectable options—for example, the time or date on your system
- To enable or disable any integrated device in your system

After you set up your system, run the System Setup program to familiarize yourself with your system configuration information and optional settings. Print the System Setup screens (by pressing <Print Screen>) or record the information for future reference.

Entering the System Setup Program

 **NOTE:** To use the System Setup program, connect a keyboard, monitor, and mouse to the system or use the console redirection function on the serial port 1 (COM1) connector. See Figure 3-3 for the serial port location. See "[Using Console Redirection](#)" for more information on console redirection.

1. Turn on your system.

If your system is already on, shut it down, and then turn it on again.

2. Press <F2> immediately after you see the following message in the upper-right corner of the screen:

<F2> = System Setup

You can also press <F12> for PXE Boot. PXE Boot forces a system boot from the network.

If you wait too long and your operating system begins to load into memory, let the system complete the load operation, and then shut down the system and try again.

 **NOTE:** To ensure an orderly system shutdown, consult the documentation that accompanied your operating system.

You can also enter the System Setup program by responding to certain error messages. See "[Responding to Error Messages](#)."

 **NOTE:** For help using the System Setup program, press <F1> while in the program.

Responding to Error Messages

If an error message appears on your monitor screen while the system is starting up, make a note of the message. Before entering the System Setup program, see "System Beep Codes" and "System Messages" in your *Installation and Troubleshooting Guide* for an explanation of the message and suggestions for correcting any errors.

 **NOTE:** To use the System Setup program and to see and respond to error messages, connect a keyboard, monitor, and mouse to the system or use the console redirection function on the serial port 1 (COM1) connector. See Figure 3-3 for the serial port location. See "[Using Console Redirection](#)" for more information on console redirection.

 **NOTE:** After installing a memory upgrade, it is normal for your system to send a message the first time you start your system. In that situation, do not refer to "System Beep Codes" and "System Messages." Instead, see "Adding Memory" in your *Installation and Troubleshooting Guide* for instructions.

If you are given an option of pressing either <F1> to continue or <F2> to run the System Setup program, press <F2>.

Using the System Setup Program

[Table 2-1](#) lists the keys that you use to view or change information on the System Setup screens and to exit the program.

Table 2-1. System Setup Navigation Keys

Keys	Action
Down arrow or <Tab>	Moves to the next field.
Up arrow or <Shift><Tab>	Moves to the previous field.
Left and right arrows or Spacebar	Cycles through the settings in a field. In many fields, you can also type the appropriate value.
<Esc>	Exits the System Setup program and restarts the system if any changes were made.

For most of the options, any changes you make are recorded but do not take effect until the next time you start the system. For a few options (as noted in the help area), the changes take effect immediately.

System Setup Options

The following subsections outline the options on the System Setup screens.

Main Screen

When the System Setup program runs, the main program screen appears (see [Figure 2-1](#)).

Figure 2-1. Main System Setup Screen

Intel® Xeon™ Processor
Processor Speed: 1.8 GHz

BIOS Version: XXXX
Service Tag : XXXXXX

```

System Time ..... 06:12:45
System Date ..... Tue May 28, 2002

Diskette Drive A: ..... 3.5 inch, 1.44 MB

System Memory ..... 512 MB ECC DDR
Video Memory ..... 8 MB SDRAM

OS Install Mode ..... OFF
CPU Information ..... <ENTER>

Boot Sequence ..... <ENTER>
Hard-Disk Drive Sequence ..... <ENTER>

Integrated Devices ..... <ENTER>
PCI IRQ Assignment ..... <ENTER>
PCI-X Slot Information ..... <ENTER>

Console Redirection ..... <ENTER>

System Security ..... <ENTER>

Keyboard NumLock ..... On
Report Keyboard Errors ..... Report

Asset Tag ..... XXXXXX

```

Up,Down Arrow to select | SPACE,+, - to change | ESC to exit | F1=HELP

The following options and information fields appear on the main **System Setup** screen:

- **System Time** — Resets the time on the system's internal clock.
- **System Date** — Resets the date on the system's internal calendar.
- **Diskette Drive A:** — Displays a screen that allows you to select the type of diskette drive for your system.
- **System Memory** — Displays the amount of system memory. This option has no user-selectable settings.
- **Video Memory** — Displays the amount of video memory. This option has no user-selectable settings.
- **OS Install Mode** — Determines the maximum amount of memory available to the operating system. **On** sets the maximum memory available to the operating system to 256 MB. **Off** (default) makes all of the system memory available to the operating system. Some operating systems will not install with more than 2 GB of system memory. Turn this option **On** during operating system installation and **Off** after installation.
- **CPU Information** — Displays information related to the microprocessor bus and microprocessors. Enables or disables the logical processor.
- **Boot Sequence** — Displays the **Boot Sequence** screen, discussed later in this section.
- **Hard-Disk Drive Sequence** — Displays the **Hard-Disk Drive Sequence** screen, discussed later in this section.
- **Integrated Devices** — Displays the Integrated Devices screen, discussed later in this section.
- **PCI IRQ Assignment** — Displays a screen that allows you to change the IRQ assigned to each of the integrated devices on the PCI bus, and any installed expansion cards that require an IRQ.
- **PCI-X Slot Information** — Displays a menu of the four selectable fields: **PCIX Bus 1**, **PCIX Bus 2**, **PCIX Bus 3**, and **PCIX Bus 4**. Selecting any one of these fields displays the following information for the PCI-X bus you selected:
 - Whether or not the PCI-X slot(s) for the bus are occupied.
 - For occupied PCI-X slots, the operating frequency of the slot. For unoccupied slots, the maximum operating frequency of the slot.
 - For occupied PCI-X slots, the operating mode of the slot (PCI or PCI-X). For unoccupied slots, the capable operating mode of the slot.

- **Console Redirection** — Displays a screen that allows you to configure console redirection, discussed later in this section. For more information on using console redirection, see Appendix C, "[Using Console Redirection](#)."
- **System Security** — Displays a screen that allows you to configure the system password and setup password features. See "[Using the System Password Feature](#)" and "[Using the Setup Password Feature](#)" for more information.
- **Keyboard NumLock** — Determines whether your system starts up with the NumLock mode activated on 101- or 102-key keyboards (does not apply to 84-key keyboards).
- **Report Keyboard Errors** — Enables or disables reporting of keyboard errors during the POST. This option is useful when applied to self-starting or host systems that have no permanently attached keyboard. In these situations, selecting **Do Not Report** suppresses all error messages relating to the keyboard or keyboard controller during POST. This setting does not affect the operation of the keyboard itself if a keyboard is attached to the system.
- **Asset Tag** — Displays the customer-programmable asset tag number for the system if an asset tag number has been assigned. See your *Resource* CD for additional information on the asset tag utility.

Boot Sequence Screen

The **Boot Sequence** screen options determine the order in which the system looks for boot devices that it needs to load during system startup. Available options include the diskette drive, CD drive, network, and hard drives. You can enable or disable a device by selecting it and pressing the spacebar. To change the order in which devices are searched, use the <+> and <-> keys.

Hard-Disk Drive Sequence Screen

The **Hard-Disk Drive Sequence** screen options determine the order in which the system searches the hard drives for the files that it needs to load during system startup. The choices depend on the particular hard drives installed in your system. To change the order in which devices are searched, use the <+> and <-> keys. Press <Enter> to confirm your selection.

- ➡ **NOTICE:** Although you can change the device search order in the **Hard-Disk Drive Sequence** screen and select the boot drive, Dell recommends that you do not change the default order in the **Hard-Disk Drive Sequence** screen.

Integrated Devices Screen

This screen is used to configure the following devices:

- **Embedded RAID controller** — Both channels A and B have the same settings. The configurable options will vary, depending on the type of ROMB card installed in your system.

The ROMB card is set to **RAID Enabled** by default for RAID functionality. Do not disable RAID functionality.

- ➡ **NOTICE:** If you disable RAID functionality on your system, all data will be lost.

- **IDE CD-ROM Controller** — Configures the integrated IDE controller. When set to **Auto**, each channel of the integrated IDE controller is enabled if IDE devices are attached to the channel and no external IDE controller is detected. Otherwise, the channel is disabled.
- **Diskette Controller** — Enables or disables the system's diskette drive controller. When **Auto** (default) is selected, the system turns off the controller when necessary to accommodate a controller card installed in an expansion slot. You can also set up the drive to be read-only. Using the read-only setting, the drive cannot be used to write to a disk.
- **USB Controller** — Allows you to enable the USB ports with BIOS support, enable the USB ports without BIOS support or disable the system's USB ports. Disabling the USB ports makes system resources available for other devices.
- **Embedded 10/100/1000 NIC** — Enables or disables the system's integrated NIC. Options are **Enabled without PXE**, **Enabled with PXE**, and **Disabled**. PXE support allows the system to boot from the network. Changes take effect after the system reboots.
- **MAC Address** — Displays the address of the MAC address for the 10/100/1000 NIC that is used by the corresponding

integrated NIC. This field has no user-selectable settings.

- **Serial Port (1 and 2)** — Configures the system's integrated serial ports. When set to **Auto**, the integrated port automatically maps to the next available port. Serial Port 1 tries to use COM1, then COM3. Serial Port 2 tries to use COM2, then COM4. If both addresses are in use for a specific port, the port is disabled.

If you set the serial port to **Auto** and add an expansion card with a port configured to the same designation, the system automatically remaps the integrated port to the next available port designation that shares the same IRQ setting.

- **Parallel Port** — Allows you to select the address for the parallel port. The default address is 378h.

The system automatically disables the built-in parallel port if an expansion card containing a parallel port at the same address is detected.

- **Parallel Port Mode** — Toggles the parallel port mode of operation between AT mode and PS/2 mode. In AT mode, the integrated parallel port can only output data to an attached device. In PS/2 mode, the built-in parallel port can both input and output data.
- **Speaker** — Toggles the integrated speaker **On** (default) or **Off**. A change to this option takes effect immediately (rebooting the system is not required).

System Security Screen

You can set the following security features through the **System Security** screen:

- **Password Status** — When **Setup Password** is set to **Enabled**, this feature allows you to prevent the system password from being changed or disabled at system start-up.

To lock the system password, you must first assign a setup password in the **Setup Password** option and then change the **Password Status** option to **Locked**. In this state, the system password cannot be changed through the **System Password** option and cannot be disabled at system start-up by pressing <Ctrl><Enter>.

To unlock the system password, you must enter the setup password in the **Setup Password** option and then change the **Password Status** option to **Unlocked**. In this state, the system password can be disabled at system start-up by pressing <Ctrl><Enter> and then changed through the **System Password** option.

- **Setup Password** — Allows you to restrict access to the System Setup program in the same way that you restrict access to your system with the system password feature.

 **NOTE:** See "[Using the Setup Password Feature](#)" for instructions on assigning a setup password and using or changing an existing setup password. See "[Disabling a Forgotten Password](#)" for instructions on disabling a forgotten setup password.

- **System Password** — Displays the current status of your system's password security feature and allows you to assign and verify a new system password.

 **NOTE:** See "[Using the System Password Feature](#)" for instructions on assigning a system password and using or changing an existing system password. See "[Disabling a Forgotten Password](#)" for instructions on disabling a forgotten system password.

- **Front-Bezel Chassis Intrusion** — Selecting this field allows you to enable or disable the chassis-intrusion detection feature.

 **NOTE:** You can still turn a system on using the power button, even if the **Power Button** option is set to **Disabled**.

- **Power Button** — When this option is set to **Enabled**, you can use the power button to turn the system off or shut down the system if you are running an operating system that is compliant with the ACPI specification. If the system is not running an ACPI-compliant operating system, power is turned off immediately after the power button is pressed.

When this option is set to **Disabled**, you cannot use the power button to turn off the system or perform other system events.

 **NOTICE:** Use the NMI button only if directed to do so by qualified support personnel or by the operating system's documentation. Pressing this button halts the operating system and displays a diagnostic screen.

- **NMI Button** — Toggles the NMI feature **On** or **Off**.

Console Redirection Screen

This screen is used to configure the console redirection feature:

 **NOTE:** It is recommended that you do not change the console redirection defaults.

- **Console Redirection** — Toggles the console redirection feature **On** (default) or **Off**.
- **Remote Terminal Type** — Allows you to select either **VT 100/VT 220** (default) or **ANSI**.
- **Redirection after Boot** — Enables (default) or disables console redirection after your system restarts.

Exit Screen

After you press <Esc> to exit the System Setup program, the **Exit** screen displays the following options:

- Save Changes and Exit
- Discard Changes and Exit
- Return to Setup

Using the System Password Feature

 **NOTICE:** The password features provide a basic level of security for the data on your system. If your data requires more security, it is your responsibility to obtain and use additional forms of protection, such as data encryption programs.

 **NOTE:** Dell recommends that the system password be left in the **Not Enabled** (default) setting. If the **System Password** option is set to **Enabled** when operating your system in the headless configuration, you will not be able to enter a system password in order to reboot the system.

 **NOTE:** To use the System Setup program, connect a keyboard, monitor, and mouse to the system or use the console redirection function on the serial port 1 (COM1) connector. See Figure 3-3 for the serial port location. See "[Using Console Redirection](#)" for more information on console redirection.

Your system is shipped to you without the system password feature enabled. If system security is a concern, you should operate your system only with system password protection.

You can assign a system password whenever you use the System Setup program. After a system password is assigned, only those who know the password have full use of the system.

When the **System Password** option is set to **Enabled**, the system prompts you for the system password just after the system starts.

To change an existing system password, you must know the password (see "[Deleting or Changing an Existing System Password](#)"). If you assign and later forget a system password, a trained service technician must remove the system cover to change a jumper setting that disables the system password feature (see "[Disabling a Forgotten Password](#)"). Note that this erases the setup password at the same time.

 **NOTICE:** If you leave your system running and unattended without having a system password assigned or if you leave your system unlocked so that someone can disable the password by changing a jumper setting, anyone can access the data stored on your hard drive.

Assigning a System Password

Before you can assign a system password, you must enter the System Setup program and check the **System Password** option.

When a system password is assigned, the setting shown for the **System Password** option is **Enabled**. If the **Password Status** option is **Unlocked**, you can change the system password. If the **Password Status** option is **Locked**, you cannot change the system password. When the system password feature is disabled by a jumper setting on the system board, the setting shown is **Disabled**, and you cannot change or enter a new system password.

When no system password is assigned and the password jumper on the system board is in the enabled (default) position, the setting shown for the **System Password** option is **Not Enabled** and the **Password Status** field is **Unlocked**. To assign a system password, perform the following steps:

1. Verify that the **Password Status** option is set to **Unlocked**.
2. Highlight the **System Password** option and then press <Enter>.
3. Type your new system password.

You can use up to 32 characters in your password.

As you press each character key (or the spacebar for a blank space), a placeholder appears in the field.

The password assignment operation recognizes keys by their location on the keyboard without distinguishing between lowercase and uppercase characters. For example, if you have an *M* in your password, the system recognizes either *M* or *m* as correct. Certain key combinations are not valid. If you enter one of these combinations, the speaker emits a beep. To erase a character when entering your password, press the <Backspace> key or the left-arrow key.

 **NOTE:** To escape from the field without assigning a system password, press <Enter> to move to another field, or press <Esc> at any time prior to completing step 5.

4. Press <Enter>.
5. To confirm your password, type it a second time and press <Enter>.

The **System Password** option changes to **Enabled**. Your system password is now set. You can exit the System Setup program and begin using your system.

 **NOTE:** Password protection does not take effect until you restart the system by turning the system off and then on again.

Using Your System Password to Secure Your System

Whenever you turn on or reboot your system by pressing the <Ctrl><Alt> key combination, the following prompt appears on the screen when the **Password Status** option is set to **Unlocked**:

```
Type in the password and... -- press <ENTER> to leave password security enabled. -- press <CTRL><ENTER> to
disable password security. Enter password:
```

If the **Password Status** option is set to **Locked**, the following prompt appears:

```
Type the password and press <Enter>.
```

After you type the correct system password and press <Enter>, your system completes the startup sequence and you can use the keyboard or mouse to operate your system as usual.

 **NOTE:** If you have assigned a setup password (see "[Using the Setup Password Feature](#)"), the system accepts your setup password as an alternate system password.

If a wrong or incomplete system password is entered, the following message appears:

```
** Incorrect password. **
```

```
Enter password:
```

If an incorrect or incomplete system password is entered again, the same message appears.

The third and subsequent times an incorrect or incomplete system password is entered, the system displays the following message:

```
** Incorrect password. **  
Number of unsuccessful password attempts: 3  
System halted! Must power down.
```

The number of unsuccessful attempts made to enter the correct system password can alert you to an unauthorized person attempting to use your system.

Even after your system is turned off and on, the previous message is displayed each time an incorrect or incomplete system password is entered.



NOTE: You can use the **Password Status** option in conjunction with the **System Password** and **Setup Password** options to further protect your system from unauthorized changes.

Deleting or Changing an Existing System Password

1. When prompted, press <Ctrl><Enter> to disable the existing system password, instead of pressing <Enter> to continue with the normal operation of your system.

If you are asked to enter your setup password, you may need to contact your network administrator who has the setup password.

2. Enter the System Setup program by pressing <F2> during POST.
3. Select the **System Security** screen field to verify that the **Password Status** option is set to **Unlocked**.
4. When prompted, type the system password.
5. Confirm that **Not Enabled** is displayed for the **System Password** option.

If **Not Enabled** is displayed for the **System Password** option, the system password has been deleted. If you want to assign a new password, continue to step 6. If **Not Enabled** is not displayed for the **System Password** option, press the <Alt> key combination to restart the system, and then repeat steps 2 through 5.

6. To assign a new password, follow the procedure in "[Assigning a System Password](#)."

Using the Setup Password Feature

Your system is shipped to you without the setup password feature enabled. If system security is a concern, you should operate your system with the setup password feature enabled.

You can assign a setup password whenever you use the System Setup program. After a setup password is assigned, only those who know the password have full use of the System Setup program.

To change an existing setup password, you must know the setup password (see "[Deleting or Changing an Existing Setup Password](#)"). If you assign and later forget a setup password, you cannot operate your system or change settings in the System Setup program until a trained service technician opens the system chassis, changes the password jumper setting to disable the passwords, and erases the existing passwords. This procedure is described in the *Installation and Troubleshooting Guide*.

Assigning a Setup Password

A setup password can be assigned (or changed) only when the **Setup Password** option is set to **Not Enabled**. To assign a

setup password, highlight the **Setup Password** option and press the + or - key. The system prompts you to enter and verify the password. If a character is illegal for password use, the system emits a beep.

 **NOTE:** The setup password can be the same as the system password. If the two passwords are different, the setup password can be used as an alternate system password. However, the system password cannot be used in place of the setup password.

After you verify the password, the **Setup Password** setting changes to **Enabled**. The next time you enter the System Setup program, the system prompts you for the setup password.

A change to the **Setup Password** option becomes effective immediately (restarting the system is not required).

Operating With a Setup Password Enabled

If **Setup Password** is set to **Enabled**, you must enter the correct setup password before you can modify the majority of the System Setup options. When you start the System Setup program, the program prompts you to type the password.

If you do not enter the correct password in three tries, the system lets you view, but not modify, the System Setup screens—with the following exception. If **System Password** is not set to **Enabled** and is not locked through the **Password Status** option, you can assign a system password (however, you cannot disable or change an existing system password).

 **NOTE:** You can use the **Password Status** option in conjunction with the **Setup Password** option to protect the system password from unauthorized changes.

Deleting or Changing an Existing Setup Password

1. Enter the System Setup program and select the **System Security** option.
2. Highlight the **Setup Password** option, press <Enter> to access the setup password window, and press <Enter> twice to clear the existing setup password.

The setting changes to **Not Enabled**.

3. If you want to assign a new setup password, perform the steps in "[Assigning a Setup Password](#)."

Disabling a Forgotten Password

If you forget your system or setup password, you cannot operate your system or change settings in the System Setup program until a trained service technician opens the system chassis, changes the password jumper setting to disable the passwords, and erases the existing passwords. This procedure is described in the *Installation and Troubleshooting Guide*.

[Back to Contents Page](#)

Technical Specifications

Dell™ PowerVault™ 770N NAS Systems User's Guide

- [Microprocessor](#)
- [Expansion Bus](#)
- [Memory](#)
- [Drives](#)
- [Ports and Connectors](#)
- [Video](#)
- [Power](#)
- [Physical](#)
- [Environmental](#)

Microprocessor	
Microprocessor type	one or two Intel® Xeon™ microprocessors
Front-side bus (external) speed	at least 400 MHz
Internal cache	512 KB cache
Math coprocessor	internal to microprocessor

Expansion Bus	
Bus type	PCI/PCI-X
Expansion slots	six dedicated PCI/PCI-X (full-length, 64-bit, two at 33/66/100/133 MHz, four at 33/66/100 MHz) and one dedicated PCI (32/33 MHz)

Memory	
Architecture	72-bit ECC PC-2100 DDR SDRAM DIMMs, with 2-way interleaving
Memory module sockets	six 72-bit wide 168-pin DIMM sockets
Memory module capacities	256 and 512 MB registered DDR SDRAM DIMMs
Minimum RAM	512 MB

Drives	
Diskette drive	3.5-inch, 1.44-MB diskette drive
Hard drives	up to eight 1-inch, internal Ultra320 SCSI
CD drive	one IDE CD drive

Ports and Connectors	
Externally accessible:	
Serial	two 9-pin connectors
USB	two 4-pin connectors
NIC	one RJ45 connector for integrated

	10/100/1000 NICs
Embedded remote access Ethernet	one RJ45 connector for embedded remote access card (10/100 Mbit Ethernet controller) used for remote system administration
Video	one 15-pin connector
PS/2-style keyboard	6-pin mini-DIN connector
PS/2-compatible mouse	6-pin mini-DIN connector

Video	
Video type	ATI Rage XL PCI video controller; VGA connector
Video memory	8 MB

Power	
Power supply:	
Wattage	730 W (AC)
Voltage	85–240 VAC, 50/60 Hz, 12.0 A 200–240 VAC, 50/60 Hz, 5.0 A
Heat dissipation	3100 BTU/hr
Maximum inrush current	under typical line conditions and over the entire system ambient operating range, the inrush current may reach 55 A per power supply for 10ms or less
System battery	CR2032 3.0-V lithium coin cell

Physical	
Rack:	
Height	21.7 cm (8.56 inches [5 U])
Width	48.0 cm (18.9 inches)
Depth	62.9 cm (24.75 inches)
Weight	40.9 kg (90 lb), maximum configuration
Tower:	
Height	44.5 cm (17.5 inches)
Width	23.0 cm (9.125 inches)
Depth	62.5 cm (24.75 inches)
Weight	40.9 kg (90 lb), maximum configuration

Environmental	
Temperature:	
Operating	10°C to 35°C (50°F to 95°F)
Storage	–40° to 65°C (–40°F to 149°F)
Relative humidity:	
Operating	20% to 80% (noncondensing) with a maximum humidity gradation of 10% per hour

Storage	5% to 95% (noncondensing) with a maximum humidity gradation of 10% per hour
Maximum vibration:	
Operating	0.25 G at 3 to 200 Hz for 15 minutes
Storage	0.5 G at 3 to 200 Hz for 15 minutes
Maximum shock:	
Operating	one shock pulse in the negative z axis (one pulse on system bottom) of 41 G for up to 2ms
Storage (non-operational)	six consecutively executed shock pulses in the positive and negative x, y, and z axes (one pulse on each side of the system) of 71 G for up to 2 ms
Altitude:	
Operating	-16 to 3,048 m (-50 to 10,000 ft.)
Storage	-16 to 10,600 m (-50 to 35,000 ft)
NOTE: For the full name of an abbreviation or acronym used in this table, see the " Glossary ."	

[Back to Contents Page](#)

I/O Ports and Connectors

Dell™ PowerVault™ 770N NAS Systems User's Guide

- [Serial Ports and Parallel Port](#)
- [Keyboard and Mouse Connectors](#)
- [Video Connector](#)
- [USB Connectors](#)
- [Integrated NIC Connector](#)
- [Embedded Remote Access Ethernet Connector \(Optional\)](#)

The I/O ports and connectors on your system are the gateways through which the system communicates with external devices such as a keyboard, mouse, and monitor. [Figure B-1](#) identifies back-panel I/O ports and connectors.

Figure B-1. Back-Panel I/O Ports and Connectors

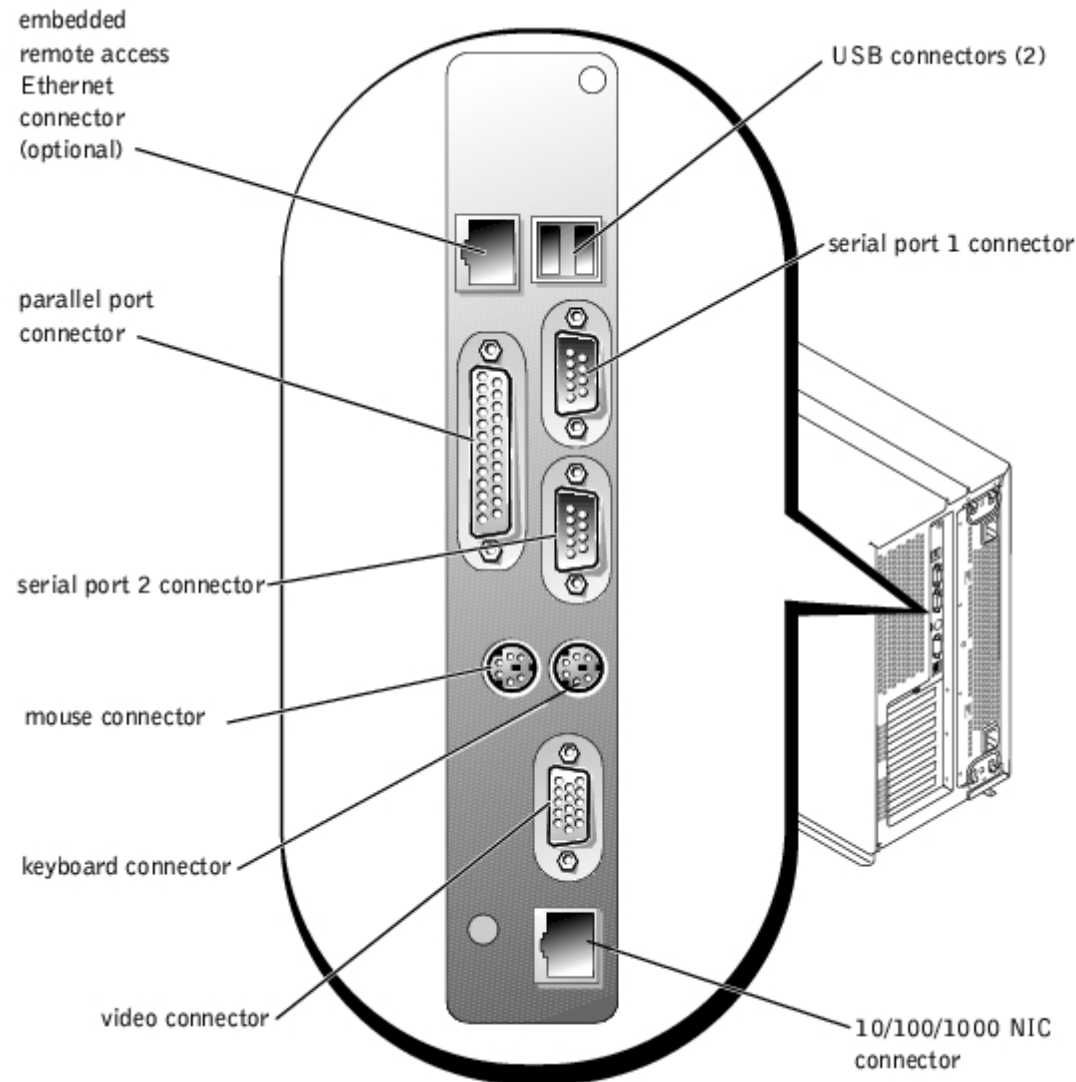

Serial Ports and Parallel Port

The integrated serial ports use 9-pin D-subminiature connectors on the back panel. These ports support devices such as external modems, printers, plotters, and mice that require serial data transmission (the transmission of data one bit at a time over one line).

Most software uses the term COM (for communications) plus a number to designate a serial port (for example, COM1 or COM2). The default designations of your system's integrated serial ports are COM1 and COM2.

The integrated parallel port uses a 25-pin D-subminiature connector on the system's back panel. This I/O port sends data in parallel format (where eight data bits, or one byte, are sent simultaneously over eight separate lines in a single cable). The parallel port is used primarily for printers.

 **NOTE:** Using this system as a print server is not supported.

Most software uses the term LPT (for line printer) plus a number to designate a parallel port (for example, LPT1). The default designation of the system's integrated parallel port is LPT1.

Port designations are used, for example, in software installation procedures that include a step in which you identify the port to which a printer is attached, thus telling the software where to send its output. (An incorrect designation prevents the printer from printing or causes scrambled print.)

Serial Port Connector

If you reconfigure your hardware, you may need pin number and signal information for the serial port connector. [Figure B-2](#) illustrates the pin numbers for the serial port connector and [Table B-1](#) defines the pin assignments and interface signals for the serial port connector.

Figure B-2. Pin Numbers for the Serial Port

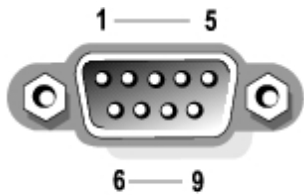

Table B-1. Serial Port Pin Assignments

Pin	Signal	I/O	Definition
1	DCD	I	Data carrier detect
2	SIN	I	Serial input
3	SOUT	O	Serial output
4	DTR	O	Data terminal ready
5	GND	N/A	Signal ground
6	DSR	I	Data set ready
7	RTS	O	Request to send
8	CTS	I	Clear to send
9	RI	I	Ring indicator
Shell	N/A	N/A	Chassis ground

Parallel Port Connector

If you reconfigure your hardware, you may need pin number and signal information for the parallel port connector. [Figure B-3](#) illustrates the pin numbers for the parallel port connector and [Table B-2](#) defines the pin assignments and interface signals for

the parallel port connector.

Figure B-3. Pin Numbers for the Parallel Port Connector

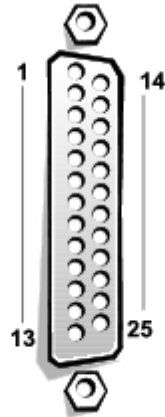

Table B-2. Parallel Port Pin Assignments

Pin	Signal	I/O	Definition
1	STB#	I/O	Strobe
2	PD0	I/O	Printer data bit 0
3	PD1	I/O	Printer data bit 1
4	PD2	I/O	Printer data bit 2
5	PD3	I/O	Printer data bit 3
6	PD4	I/O	Printer data bit 4
7	PD5	I/O	Printer data bit 5
8	PD6	I/O	Printer data bit 6
9	PD7	I/O	Printer data bit 7
10	ACK#	I	Acknowledge
11	BUSY	I	Busy
12	PE	I	Paper end
13	SLCT	I	Select
14	AFD#	O	Automatic feed
15	ERR#	I	Error
16	INIT#	O	Initialize printer
17	SLIN#	O	Select in
18–25	GND	N/A	Signal ground

Adding an Expansion Card Containing Serial or Parallel Ports

The system has an autoconfiguration capability for the serial ports. This feature lets you add an expansion card containing a serial port that has the same designation as one of the integrated ports, without having to reconfigure the card. When the system detects the duplicate serial port on the expansion card, it remaps (reassigns) the integrated port to the next available port designation.

Both the new and the remapped COM ports share the same IRQ setting, as follows:

COM1, COM3: IRQ4 (shared setting)

COM2, COM4: IRQ3 (shared setting)

These COM ports have the following I/O address settings:

COM1: 3F8h

COM2: 2F8h

COM3: 3E8h

COM4: 2E8h

For example, if you add an internal modem card with a port configured as COM1, the system then sees logical COM1 as the address on the modem card. It automatically remaps the integrated serial port that was designated as COM1 to COM3, which shares the COM1 IRQ setting. (Note that when you have two COM ports sharing an IRQ setting, you can use either port as necessary but you may not be able to use them both at the same time.) If you install one or more expansion cards with serial ports designated as COM1 and COM3, the corresponding integrated serial port is disabled.

Before adding a card that remaps the COM ports, check the documentation that accompanied your software to make sure that the software can be mapped to the new COM port designation.

To avoid autoconfiguration, you may be able to reset jumpers on the expansion card so that the card's port designation changes to the next available COM number, leaving the designation for the integrated port as is. Alternatively, you can disable the integrated ports through the System Setup program. The documentation for your expansion card should provide the card's default I/O address and allowable IRQ settings. It should also provide instructions for readdressing the port and changing the IRQ setting, if necessary.

For general information on how your operating system handles serial and parallel ports, and for more detailed command procedures, see your operating system documentation.

Keyboard and Mouse Connectors

The system uses a PS/2-style keyboard and supports a PS/2-compatible mouse. Cables from both devices attach to 6-pin, miniature DIN connectors on the back panel of your system.

 **NOTE:** Mouse driver software can give the mouse priority with the microprocessor by issuing IRQ12 whenever a new mouse movement is detected. The driver software also passes along the mouse data to the application program that is in control.

 **NOTE:** Your system is a "headless" system that is managed through the onboard Ethernet connection; the system operates without a keyboard, monitor, or mouse. While it is possible to connect these peripherals to the system, it is generally not necessary unless you are troubleshooting the system.

Keyboard Connector

The following information is pin information for the keyboard connector. [Figure B-4](#) illustrates the pin numbers for the keyboard connector. [Table B-3](#) defines the pin assignments and interface signals for the keyboard connector.

Figure B-4. Pin Numbers for the Keyboard Connector



Table B-3. Keyboard Connector Pin Assignments

Pin	Signal	I/O	Definition
1	KBDATA	I/O	Keyboard data
2	NC	N/A	No connection

3	GND	N/A	Signal ground
4	FVcc	N/A	Fused supply voltage
5	KBCLK	I/O	Keyboard clock
6	NC	N/A	No connection
Shell	N/A	N/A	Chassis ground

Mouse Connector

The following is pin information for the mouse connector. [Figure B-5](#) illustrates the pin numbers for the mouse connector. [Table B-4](#) defines the pin assignments and interface signals for the mouse connector.

Figure B-5. Pin Numbers for the Mouse Connector

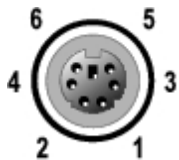

Table B-4. Mouse Connector Pin Assignments (Back Panel)

Pin	Signal	I/O	Definition
1	MSDATA	I/O	Mouse data
2	NC	N/A	No connection
3	GND	N/A	Signal ground
4	FVcc	N/A	Fused supply voltage
5	MSCLK	I/O	Mouse clock
6	NC	N/A	No connection
Shell	N/A	N/A	Chassis ground

Video Connector

The system uses a 15-pin high-density D-subminiature connector on the front and back panels for attaching a VGA-compatible monitor to your system. The video circuitry on the system board synchronizes the signals that drive the red, green, and blue electron guns in the monitor.

If you reconfigure your hardware, you may need pin number and signal information for the video connector. [Figure B-6](#) illustrates the pin numbers for the video connector, and [Table B-5](#) defines the pin assignments and interface signals for the video connector.

Figure B-6. Pin Numbers for the Video Connector

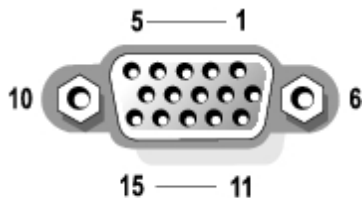

Table B-5. Video Connector Pin Assignments

Pin	Signal	I/O	Definition
1	RED	O	Red video
2	GREEN	O	Green video
3	BLUE	O	Blue video
4	NC	N/A	No connection
5–8, 10	GND	N/A	Signal ground
9	VCC	N/A	Vcc
11	NC	N/A	No connection
12	DDC data out	O	Monitor detect data
13	HSYNC	O	Horizontal synchronization
14	VSYNC	O	Vertical synchronization
15	DDC clock out	O	Monitor detect clock
Shell	N/A	N/A	Chassis ground

USB Connectors

Your system contains two USB connectors on the rear panel for attaching USB-compliant devices. USB devices are typically peripherals such as mice, keyboards, and system speakers.

- ➔ **NOTICE:** Do not attach a USB device or a combination of USB devices that draw a maximum current over 500 mA per channel on +5 V. Attaching devices that exceed this threshold may cause the USB ports to shut down. See the documentation that accompanied the USB devices for their maximum current ratings.

If you reconfigure your hardware, you may need pin number and signal information for the USB connectors. [Figure B-7](#) illustrates the USB connector and [Table B-6](#) defines the pin assignments and interface signals for the USB connector.

Figure B-7. Pin Numbers for the USB Connector



Table B-6. USB Connector Pin Assignments

Pin	Signal	I/O	Definition
1	Vcc	N/A	Supply voltage

2	DATA-	I/O	Data
3	DATA+	I/O	Data
4	GND	N/A	Signal ground

Integrated NIC Connector

Your system has one integrated 10/100/1000 Mbps NIC (see [Figure B-8](#)). The 10/100/1000 Mbps NIC connectors provide faster communication between servers and workstations and efficient utilization of host resources, freeing more of the system resources for other applications. The NIC supports 10 Base-T, 100 Base-TX, and 1000 Base-T Ethernet standards.

The NIC includes a Wake On LAN feature that enables the system to be started by a special LAN signal from a systems management console. Wake On LAN provides remote system setup, software downloading and installation, file updates, and asset tracking after hours and on weekends when LAN traffic is typically at a minimum.

Figure B-8. Integrated NIC Connector

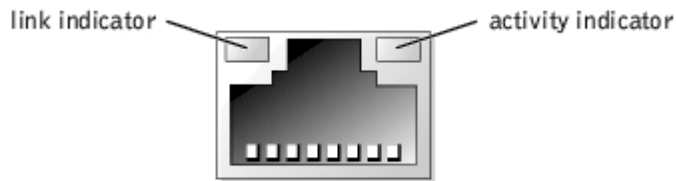

Network Cable Requirements

Your system's RJ45 NIC connector is designed for attaching a UTP Ethernet cable equipped with standard RJ45-compatible plugs. Press one end of the UTP cable into the NIC connector until the plug snaps securely into place. Connect the other end of the cable to an RJ45 jack wall plate or to an RJ45 port on a UTP concentrator or hub, depending on your network configuration. Observe the following cabling restrictions for 10 Base-T, 100 Base-TX, and 1000 Base-T networks.

NOTICE: To avoid line interference, voice, and data lines must be in separate sheaths.

- Use Category 5 or greater wiring and connectors.
- The maximum cable run length (from a system to a hub) is 328 ft (100 m).
- You can find guidelines for operation of a network in "Systems Considerations of Multi-Segment Networks" in the IEEE 802.3 standard.

Embedded Remote Access Ethernet Connector (Optional)

Your system's optional embedded remote access Ethernet connector (see [Figure B-9](#)) is designed to provide remote access capabilities for your system. It is designed specifically to work with systems management software.

Figure B-9. Embedded Remote Access Ethernet Connector

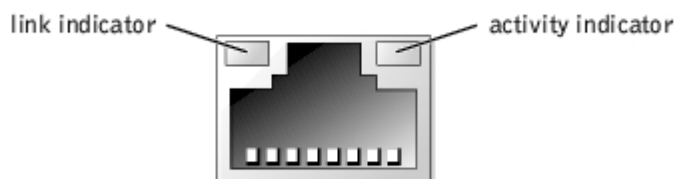

[Back to Contents Page](#)

Using Console Redirection

Dell™ PowerVault™ 770N NAS Systems User's Guide

- [Minimum Hardware and Connection Requirements](#)
- [Software Requirements](#)
- [Configuring Console Redirection on the System](#)
- [Configuring Console Redirection on the Client System](#)
- [Rebooting the System](#)
- [Configuring Special Keys](#)

Console redirection allows you to maintain a system from a remote location by re-directing keyboard input and text output through the serial port. Graphic output is not redirected. Console redirection can be used under MS-DOS® for tasks such as setting up a common BIOS configuration or setting up a RAID configuration. In a typical installation, the system is connected to a port concentrator that allows you to connect several systems using a shared modem. After you use a modem or other remote connection to log into the port concentrator, you can select which system you want to manage with console redirection. This section describes the simplest connection possible: connecting to a system with a null modem cable.

Minimum Hardware and Connection Requirements

To use console redirection, you must have the following:

- An available serial port (COM port) on a client system

This port must not conflict with any other ports on the system.

- Available serial port (COM) on the server

For systems with two available serial ports, you can use either the COM 1 or COM 2 port.

- A null modem cable to connect the server to the client system
-

Software Requirements

Your remote terminal emulation software should meet the following specifications:

- ANSI or VT100/220 terminal emulation with a window size of 80 x 25 characters
- 9600, 19.2 K, 57.6 K, or 115.2 Kbps using serial (COM) ports
- Recommended: the ability to create keyboard command macros

All versions of the Microsoft® Windows® operating systems come with Hyper-Terminal terminal emulation software. However, the version of HyperTerminal included with most Windows operating systems does not provide the correct screen size, the arrow and function keys do not work, and there is no method of creating macros. Dell recommends that you either upgrade your version of HyperTerminal to HyperTerminal Private Edition 6.1 or later or select new terminal emulation software.

Configuring Console Redirection on the System

Console redirection is configured through the System Setup program (see "[Using the System Setup Program](#)" for

instructions). The Console Redirection option displays a screen that allows you to configure console redirection. The submenu allows you to turn the feature on or off, select the remote terminal type, and enable or disable redirection after booting. The options available are listed in [Table C-1](#).

Table C-1. Terminal Emulation Types

Selection	Options
Console Redirection	Systems with one serial port: On Off Systems with two serial ports: Serial Port 1 Serial Port 2 Off
Remote Terminal Type	VT 100/220 ANSI
Redirection after boot	Enabled Disabled

If you select VT 100/220 but not all the characters are visible on the screen, go back to the System Setup program and select ANSI as your terminal type. ANSI can display the full set of ASCII characters.

Configuring Console Redirection on the Client System



NOTE: The examples in this document assume that you have upgraded to Hilgraeve's HyperTerminal Private Edition 6.1 or later. If you are using other terminal emulation software, see the help file for that software.

Configuring the Ports

1. Click the **Start** button, point to **Programs® Accessories® Communications**, and click **HyperTerminal**.
2. Enter any name for the new connection and select any icon.
3. Click **OK**.
4. From the **Connect to** pull-down menu, select a COM port available on your client system and click **OK**.

If no COM port is available and you do not have a Dell™ system, you need to contact technical support for your client system.

After you have selected an available COM port, the COM port properties window is displayed.

5. Select **Bits per second**.

Console redirection supports 9600, 19.2 K, 57.6 K, or 115.2 K bps.

6. Set **Data bits** to **8**.
7. Set **Parity** to **None**.
8. Set **Stop bits** to **1**.
9. Set **Flow control** to **Hardware**.
10. Click **OK**.

Configuring the Terminal Settings

After you configure the ports, configure the terminal settings by performing the following steps:

1. In HyperTerminal, click **File**, click **Properties**, and select the **Settings** tab.
2. Ensure that the **Function, arrow, and Ctrl keys act as** field is set to **Terminal Keys**.
3. Ensure that the **Backspace key sends** field is set to **Ctrl+H**.
4. Change the **Emulation** setting from **Auto detect** to **ANSI** or **VT 100/220**.

This setting should be the same as the setting you selected for the Console Redirection option on the server.

When you click **Terminal Setup**, you should see a setting for the number of rows and columns.

5. Change the number of rows from **24** to **25** and leave the number of columns at **80**. If you do not have these settings, then you must upgrade your terminal emulation software.

Rebooting the System

Console redirection is designed to yield control of the serial ports to the operating system. This configuration allows serial debugging and redirection of the operating system to function correctly without interference from the system BIOS.

To use console redirection to shut down a system and troubleshoot it or to change BIOS configurations, perform the following steps:

1. Reboot the system. See [Table C-4](#) for a recommendation on how to do this.
2. When the system begins to reboot, use console redirection to watch and interact with the system during the POST. While the system is booting, you can do the following:
 - Enter the System Setup program.
 - Enter the SCSI setup menus.
 - Update firmware and BIOS (flash the system).

Configuring Special Keys

Console redirection uses ANSI or VT 100/220 terminal emulation, which are limited to basic ASCII characters. Function keys, arrow keys, and control keys are not available in this character set. However, most BIOS software requires the use of function keys and control keys for ordinary functions. You can emulate a function key or control key by using a special key sequence, called an escape sequence, to represent a specific key.

For console redirection, an escape sequence starts with an escape character. This character can be entered in a number of different ways, depending on the requirements of your terminal emulation software. For example, `0x1b`, `^[`, and `<Esc>` all refer to the same escape character. Some terminal software uses predefined macros to send the proper escape sequences. In HyperTerminal, you can define macros by selecting Key Macros from the View menu. Macros can be assigned to almost any possible key for almost any key combination. Create a macro for each of your function keys. [Table C-2](#) and [Table C-3](#) list the VT 100/220 escape sequences that must be sent to represent a special key or command.



NOTE: When defining macros in HyperTerminal, you must press `<Ins>` before `<Esc>` to signify that you are sending an escape sequence rather than escaping out of the dialog box. If you do not have these settings, this is an indication that you must upgrade your terminal emulation software.

Table C-2. VT 100/220 Supported Escape Sequences

Key	Supported Sequences	Terminal Emulation
Up arrow	<Esc> [<Shift>a	VT100/220
Down arrow	<Esc> [<Shift>b	VT100/220
Right arrow	<Esc> [<Shift>c	VT100/220
Left arrow	<Esc> [<Shift>d	VT100/220
F1	<Esc> <Shift>op	VT100/220
F2	<Esc> <Shift>oq	VT100/220
F3	<Esc> <Shift>or	VT100/220
F4	<Esc> <Shift>os	VT100/220
F5	<Esc> <Shift>ot	VT100
F6	<Esc> <Shift>ou <Esc> [1 7 ~	VT100 VT100/220
F7	<Esc> <Shift>ov <Esc> [1 8 ~	VT100 VT100/220
F8	<Esc> <Shift>ow <Esc> [1 9 ~	VT100 VT100/220
F9	<Esc> <Shift>ox <Esc> [2 0 ~	VT100 VT100/220
F10	<Esc> <Shift>oy <Esc> [2 1 ~	VT100 VT100/220
F11	<Esc> <Shift>oz <Esc> [2 3 ~	VT100 VT100/220
F12	<Esc> <Shift>oa <Esc> [2 4 ~	VT100 VT100/220
Home	<Esc> [1 ~	VT220
End	<Esc> [4 ~	VT220
Insert	<Esc> [2 ~	VT220
Delete	<Esc> [3 ~	VT220
Page Up	<Esc> [5 ~	VT220
Page Down	<Esc> [6 ~	VT220
Shift-Tab	<Esc> [<Shift>z <Esc> [0 <Shift>z	VT100 VT220

Table C-3. ANSI Supported Escape Sequences

Key	Supported Sequences
Up arrow	<Esc> [<Shift>a
Down arrow	<Esc> [<Shift>b
Right arrow	<Esc> [<Shift>c
Left arrow	<Esc> [<Shift>d
F1	<Esc> <Shift>op
F2	<Esc> <Shift>oq
F3	<Esc> <Shift>or
F4	<Esc> <Shift>os
F5	<Esc> <Shift>ot

F6	<Esc> <Shift>ou
F7	<Esc> <Shift>ov
F8	<Esc> <Shift>ow
F9	<Esc> <Shift>ox
F10	<Esc> <Shift>oy
F11	<Esc> <Shift>oz
F12	<Esc> <Shift>oa

After you create these macros, pressing <F1> on the keyboard while running the terminal emulation software sends <Esc><Shift>op to the server. When these three characters are transmitted, the server interprets them as <F1>. You need this functionality to change the settings in the System Setup program or to continue if there is an error on your system and you are prompted to press <F1>.

In addition to macros for the function keys, Dell recommends that you set up macros for the additional escape sequences listed in [Table C-4](#).

Table C-4. Additional Escape Sequences

Key Combination	Supported Sequence
<Alt><x>	<Esc> <Shift> x <Shift> x
<Ctrl><Alt> (This key combination reboots the system.)	<Esc> <Shift>r <Esc> r <Esc> <Shift>r
<Ctrl><Shift>i	<Esc> <Ctrl><Shift>i
<Ctrl><Shift>j	<Esc> <Ctrl><Shift>j
<Ctrl><Shift>h	<Esc> <Ctrl><Shift>h
<Ctrl><Shift>m	<Esc> <Ctrl><Shift>m
<Ctrl>2	<Esc> <Ctrl>2

[Back to Contents Page](#)

Glossary

Dell™ PowerVault™ 770N NAS Systems User's Guide

The following list defines or identifies technical terms, abbreviations, and acronyms used in your system documents.

A

Abbreviation for ampere(s).

AC

Abbreviation for alternating current.

ACPI

Abbreviation for Advanced Configuration and Power Interface.

adapter card

An expansion card that plugs into an expansion-card connector on the computer's system board. An adapter card adds some specialized function to the system by providing an interface between the expansion bus and a peripheral device. Examples of adapter cards include network cards, sound cards, and SCSI adapters.

ambient temperature

The temperature of the area or room where the system is located. Also known as room temperature.

ANSI

Abbreviation for American National Standards Institute.

application

Software, such as a spreadsheet or word processor, designed to help you perform a specific task or series of tasks. Application programs run from the operating system.

asset tag code

An individual code assigned to a system, usually by a system administrator, for security or tracking purposes.

backup

A copy of a program or data file. As a precaution, you should back up your system's hard drive on a regular basis. Before making a change to the configuration of your system, you should back up important start-up files from your operating system.

backup battery

The backup battery maintains system configuration, date, and time information in a special section of memory when the system is turned off.

beep code

A diagnostic message in the form of a pattern of beeps from your system's speaker. For example, one beep, followed by a second beep, and then a burst of three beeps is beep code 1-1-3.

BIOS

Acronym for basic input/output system. Your system's BIOS contains programs stored on a flash memory chip. The BIOS controls the following:

- Communications between the microprocessor and peripheral devices, such as the keyboard and the video adapter
- Miscellaneous functions, such as system messages

bit

The smallest unit of information interpreted by your system.

boot routine

When you start your system, it clears all memory, initializes devices, and loads the operating system. Unless the operating system fails to respond, you can reboot (also called *warm boot*) your system by pressing <Ctrl><Alt>; otherwise, you must perform a cold boot by pressing the reset button or by turning the system off and then back on.

bootable diskette

You can start your system from a bootable diskette. To make a bootable diskette, insert a diskette in the diskette drive, type `sys a:` at the command line prompt, and press <Enter>. Use this bootable diskette if your system will not boot from the hard drive.

bps

Abbreviation for bits per second.

BTU

Abbreviation for British thermal unit.

bus

An information pathway between the components of a system. Your system contains an expansion bus that allows the microprocessor to communicate with controllers for all the various peripheral devices connected to the system. Your system also contains an address bus and a data bus for communications between the microprocessor and RAM.

byte

Eight contiguous bits of information, the basic data unit used by your system.

C

Abbreviation for Celsius.

cache

A fast storage area that keeps a copy of data or instructions for quicker data retrieval. For example, your system's BIOS may

cache ROM code in faster RAM. Or, a disk-cache utility may reserve RAM in which to store frequently accessed information from your system's disk drives; when a program makes a request to a disk drive for data that is in the cache, the disk-cache utility can retrieve the data from RAM faster than from the disk drive.

CD

Abbreviation for compact disc. CD drives use optical technology to read data from CDs. CDs are read-only storage devices; you cannot write new data to a CD with standard CD drives.

COM n

The device names for the first through fourth serial ports on your system are COM1, COM2, COM3, and COM4. The default interrupt for COM1 and COM3 is IRQ4, and the default interrupt for COM2 and COM4 is IRQ3. Therefore, you must be careful when configuring software that runs a serial device so that you don't create an interrupt conflict.

component

As they relate to DMI, manageable components are operating systems, computer systems, expansion cards, and peripherals that are compatible with DMI. Each component is made up of groups and attributes that are defined as relevant to that component.

controller

A chip that controls the transfer of data between the microprocessor and memory or between the micro-processor and a peripheral device such as a disk drive or the keyboard.

control panel

The part of the system that contains indicators and controls, such as the power switch, hard drive access indicator, and power indicator.

conventional memory

The first 640 KB of RAM. Conventional memory is found in all systems. Unless they are specially designed, MS-DOS® programs are limited to running in conventional memory.

coprocessor

A chip that relieves the system's microprocessor of specific processing tasks. A math coprocessor, for example, handles numeric processing. A graphics coprocessor handles video rendering.

CPU

Abbreviation for central processing unit. See *microprocessor*.

DC

Abbreviation for direct current.

DDR

Abbreviation for double-data rate.

device driver

A program that allows the operating system or some other program to interface correctly with a peripheral device, such as a

printer. Some device drivers—such as network drivers—must be loaded from the config.sys file (with a device= statement) or as memory-resident programs (usually, from the autoexec.bat file). Others—such as video drivers—must load when you start the program for which they were designed.

diagnostics

A comprehensive set of tests for your system. See your *Installation and Troubleshooting Guide* for more information about using diagnostics.

DIMM

Acronym for dual in-line memory module. A small circuit board containing DRAM chips that connects to the system board.

DIN

Acronym for *Deutsche Industrie Norm*.

directory

Directories help keep related files organized on a disk in a hierarchical, "inverted tree" structure. Each disk has a "root" directory; for example, a `c:\>` prompt normally indicates that you are at the root directory of hard drive C. Additional directories that branch off the root directory are called *subdirectories*. Subdirectories may contain additional directories branching off them.

DMA

Abbreviation for direct memory access. A DMA channel allows certain types of data transfer between RAM and a device to bypass the microprocessor.

DMI

Abbreviation for Desktop Management Interface. DMI enables the management of your system's software and hardware. DMI collects information about the system's components, such as the operating system, memory, peripherals, expansion cards, and asset tag. Information about the system's components is displayed as a MIF file.

DRAM

Abbreviation for dynamic random-access memory. A system's RAM is usually made up entirely of DRAM chips. Because DRAM chips cannot store an electrical charge indefinitely, your system continually refreshes each DRAM microprocessor in the system.

DVD

Abbreviation for digital versatile disk.

ECC

Abbreviation for error checking and correction.

EEPROM

Acronym for electrically erasable programmable read-only memory.

EISA

Acronym for Extended Industry-Standard Architecture, a 32-bit expansion-bus design. The expansion-card connectors in an

EISA system are also compatible with 8- or 16-bit ISA expansion cards.

To avoid a configuration conflict when installing an EISA expansion card, you must use the EISA Configuration Utility. This utility allows you to specify which expansion slot contains the card and obtains information about the card's required system resources from a corresponding EISA configuration file.

EMC

Abbreviation for Electromagnetic Compatibility.

EMI

Abbreviation for electromagnetic interference.

ERA

Abbreviation for embedded remote access. ERA allows you to perform remote, or "out-of-band," server management on your network server using a remote access controller.

ESD

Abbreviation for electrostatic discharge.

expanded memory

A technique for accessing RAM above 1 MB. To enable expanded memory on your system, you must use an EMM. You should configure your system to support expanded memory only if you run application programs that can use (or require) expanded memory.

expansion bus

Your system contains an expansion bus that allows the microprocessor to communicate with controllers for peripheral devices, such as a network card or an internal modem.

expansion-card connector

A connector on the system board or riser board for plugging in an expansion card.

extended memory

RAM above 1 MB. Most software that can use it, such as the Microsoft® Windows® operating system, requires that extended memory be under the control of an XMM.

external cache memory

A RAM cache using SRAM chips. Because SRAM chips operate at several times the speed of DRAM chips, the microprocessor can retrieve data and instructions faster from external cache memory than from RAM.

F

Abbreviation for Fahrenheit.

FAT

Acronym for file allocation table. The file system structure used by MS-DOS to organize and keep track of file storage. The Windows NT® operating systems can optionally use a FAT file system structure.

FCC

Abbreviation for Federal Communications Commission.

flash memory

A type of EEPROM chip that can be reprogrammed from a utility on diskette while still installed in a system; most EEPROM chips can only be rewritten with special programming equipment.

format

To prepare a hard drive or diskette for storing files. An unconditional format deletes all data stored on the disk.

FSB

Abbreviation for front side bus. The FSB is the data path and physical interface between the microprocessor and the main memory (RAM).

ft

Abbreviation for feet.

FTP

Abbreviation for file transfer protocol.

g

Abbreviation for gram(s).

G

Abbreviation for gravities.

GB

Abbreviation for gigabyte(s). A gigabyte equals 1,024 megabytes or 1,073,741,824 bytes.

graphics coprocessor

See coprocessor.

graphics mode

A video mode that can be defined as x horizontal by y vertical pixels by z colors.

group

As it relates to DMI, a group is a data structure that defines common information, or attributes, about a manageable component.

h

Abbreviation for hexadecimal. A base-16 numbering system, often used in programming to identify addresses in the system's RAM and I/O memory addresses for devices. The sequence of decimal numbers from 0 through 16, for example, is expressed in hexadecimal notation as 0, 1, 2, 3, 4, 5, 6, 7, 8, 9, A, B, C, D, E, F, 10. In text, hexadecimal numbers are often followed by *h*.

headless system

A system or device that functions without having a keyboard, mouse, or monitor attached. Normally, headless systems are managed over an internet or intranet network using an internet browser. Some systems provide for attaching a keyboard, mouse, and monitor for specific management or service needs, others do not.

host adapter

A host adapter implements communication between the system's bus and the controller for a peripheral device. (Hard drive controller subsystems include integrated host adapter circuitry.) To add a SCSI expansion bus to your system, you must install or connect the appropriate host adapter.

Hz

Abbreviation for hertz.

IDE

Abbreviation for integrated drive electronics

I/O

Abbreviation for input/output. A keyboard is an input device, and a printer is an output device. In general, I/O activity can be differentiated from computational activity. For example, when a program sends a document to the printer, it is engaging in output activity; when the program sorts a list of terms, it is engaging in computational activity.

ID

Abbreviation for identification.

interlacing

A technique for increasing video resolution by only up-dating alternate horizontal lines on the screen. Because interlacing can result in noticeable screen flicker, most users prefer noninterlaced video adapter resolutions.

internal microprocessor cache

An instruction and data cache built in to the microprocessor. The Intel® Pentium® microprocessor includes a 16-KB internal cache, which is set up as an 8-KB read-only instruction cache and an 8-KB read/write data cache.

IRQ

Abbreviation for interrupt request. A signal that data is about to be sent to or received by a peripheral device travels by an IRQ line to the microprocessor. Each peripheral connection must be assigned an IRQ number. For example, the first serial port in your system (COM1) is assigned to IRQ4 by default. Two devices can share the same IRQ assignment, but you cannot operate both devices simultaneously.

ITE

Abbreviation for information technology equipment.

jumper

Jumpers are small blocks on a circuit board with two or more pins emerging from them. Plastic plugs containing a wire fit down over the pins. The wire connects the pins and creates a circuit. Jumpers provide a simple and reversible method of changing the circuitry in a printed circuit board.

K

Abbreviation for kilo-, indicating 1,000.

KB

Abbreviation for kilobyte(s), 1,024 bytes.

KB/sec

Abbreviation for kilobyte(s) per second.

Kbit(s)

Abbreviation for kilobit(s), 1,024 bits.

Kbit(s)/sec

Abbreviation for kilobit(s) per second.

key combination

A command requiring you to press multiple keys at the same time. For example, you can reboot your system by pressing the <Ctrl><Alt> key combination.

kg

Abbreviation for kilogram(s), 1,000 grams.

KHz

Abbreviation for kilohertz, 1,000 hertz.

LAN

Acronym for local area network. A LAN system is usually confined to the same building or a few nearby buildings, with all equipment linked by wiring dedicated specifically to the LAN.

lb

Abbreviation for pound(s).

LED

Abbreviation for light-emitting diode. An electronic device that lights up when a current is passed through it.

local bus

On a system with local-bus expansion capability, certain peripheral devices (such as the video adapter circuitry) can be designed to run much faster than they would with a traditional expansion bus. Some local-bus designs allow peripherals to run at the same speed and with the same width data path as the system's microprocessor.

m

Abbreviation for meter(s).

mA

Abbreviation for milliampere(s).

MAC

Abbreviation for Media Access Control.

mAh

Abbreviation for milliampere-hour(s).

math coprocessor

See coprocessor.

Mb

Abbreviation for megabit.

MB

Abbreviation for megabyte(s). The term *megabyte* means 1,048,576 bytes; however, when referring to hard drive storage, the term is often rounded to mean 1,000,000 bytes.

MB/sec

Abbreviation for megabytes per second.

Mbps

Abbreviation for megabits per second.

MBR

Abbreviation for master boot record.

memory

A system can contain several different forms of memory, such as RAM, ROM, and video memory. Frequently, the word *memory* is used as a synonym for RAM; for example, an unqualified statement such as "a system with 16 MB of memory" refers to a system with 16 MB of RAM.

memory address

A specific location, usually expressed as a hexadecimal number, in the system's RAM.

memory module

A small circuit board containing DRAM chips that connects to the system board.

MHz

Abbreviation for megahertz.

microprocessor

The primary computational chip inside the system that controls the interpretation and execution of arithmetic and logic functions. Software written for one microprocessor must usually be revised to run on another microprocessor. *CPU* is a synonym for microprocessor.

mm

Abbreviation for millimeter(s).

mouse

A pointing device that controls the movement of the cursor on a screen. Mouse-aware software allows you to activate commands by clicking a mouse button while pointing at objects displayed on the screen.

MPEG

Acronym for Motion Picture Experts Group. MPEG is a digital video file format.

ms

Abbreviation for millisecond(s).

MS-DOS

Abbreviation for Microsoft Disk Operating System.

NAS

Abbreviation for Network Attached Storage. Network-attached storage (NAS) is one of the concepts used for implementing shared storage on a network. The network communication uses Common Internet File System (CIFS) for Microsoft Windows environments, Network File System (NFS) for UNIX® environments, FTP, http, and other networking protocols.

NAS system

A NAS system is typically a system or component that is a dedicated, high-performance, high-speed communicating system. NAS systems have their own operating systems, integrated hardware, and software that are optimized to stand alone and serve specific storage needs. Essentially NAS systems are types of plug-and-play appliances with the single purpose of serving your storage needs.

Dell's NAS systems are designed to easily add storage to a workgroup, small office, or small business network. These *headless* systems can be managed from any browser and offer data security capabilities similar to general-purpose servers. By design, NAS systems off-load file management work from the general-purpose server. Also, low-end NAS systems can be used by a peer-to-peer network to support "always-on" access to information. When a NAS system is positioned behind an Internet router, it can provide a small office with a cost effective file server that is *future proofed* by the fact that adding a general-purpose server does not obsolete the NAS system.

NDIS

Abbreviation for Network Driver Interface Specification.

NIC

Acronym for network interface controller.

NMI

Abbreviation for nonmaskable interrupt. A device sends an NMI to signal the microprocessor about hardware errors, such as a parity error.

noninterlaced

A technique for decreasing screen flicker by sequentially refreshing each horizontal line on the screen.

ns

Abbreviation for nanosecond(s), one billionth of a second.

NTFS

Abbreviation for the NT File System option in the Windows NT® operating system.

NVRAM

Abbreviation for nonvolatile random-access memory. Memory that does not lose its contents when you turn off your system. NVRAM is used for maintaining the date, time, and system configuration information.

partition

You can divide a hard drive into multiple physical sections called *partitions* with the fdisk command. Each partition can contain multiple logical drives.

After partitioning the hard drive, you must format each logical drive with the format command.

PCI

Abbreviation for Peripheral Component Interconnect. A standard for local-bus implementation developed by Intel Corporation.

peripheral device

An internal or external device—such as a printer, a disk drive, or a keyboard—connected to a system.

PGA

Abbreviation for pin grid array, a type of microprocessor socket that allows you to remove the microprocessor chip.

pixel

A single point on a video display. Pixels are arranged in rows and columns to create an image. A video resolution, such as 640 x 480, is expressed as the number of pixels across by the number of pixels up and down.

POST

Acronym for power-on self-test. Before the operating system loads when you turn on your system, the POST tests various system components such as RAM, the disk drives, and the keyboard.

program diskette set

The set of diskettes from which you can perform a complete installation of an operating system or application program. When you reconfigure a program, you often need its program diskette set.

protected mode

An operating mode supported by 80286 or higher microprocessors, protected mode allows operating systems to implement:

- A memory address space of 16 MB (80286 micro--processor) to 4 GB (Intel386™ or higher micro-processor)
- Multitasking
- Virtual memory, a method for increasing addressable memory by using the hard drive

The Windows NT and UNIX® 32-bit operating systems run in protected mode. MS-DOS cannot run in protected mode; however, some programs that you can start from MS-DOS, such as the Windows operating system, are able to put the system into protected mode.

PS/2

Abbreviation for Personal System/2.

PXE

Acronym for Preboot Execution Environment.

RAID

Acronym for redundant array of independent disks.

RAM

Acronym for random-access memory. The system's primary temporary storage area for program instructions and data. Each location in RAM is identified by a number called a *memory address*. Any information stored in RAM is lost when you turn off your system.

read-only file

A read-only file is one that you are prohibited from editing or deleting. A file can have read-only status if:

- Its read-only attribute is enabled.
- It resides on a physically write-protected diskette or on a diskette in a write-protected drive.
- It is located on a network in a directory to which the system administrator has assigned read-only rights to you.

readme file

A text file included with a software package or hardware product that contains information supplementing or updating the documentation for the software or hardware. Typically, readme files provide installation information, describe new product enhancements or corrections that have not yet been documented, and list known problems or other things you need to be aware of as you use the software or hardware.

real mode

An operating mode supported by 80286 or higher microprocessors, real mode imitates the architecture of an 8086 microprocessor.

ROM

Acronym for read-only memory. Your system contains some programs essential to its operation in ROM code. Unlike RAM, a ROM chip retains its contents even after you turn off your system. Examples of code in ROM include the program that initiates your system's boot routine and the POST.

ROMB

Acronym for RAID on Motherboard.

rpm

Abbreviation for revolutions per minute.

RTC

Abbreviation for real-time clock. Battery-powered clock circuitry inside the system that keeps the date and time after you turn off the system.

SCSI

Acronym for small computer system interface. An I/O bus interface with faster data transmission rates than standard ports. You can connect up to seven devices (15 for some newer SCSI types) to one SCSI interface.

SDMS

Abbreviation for SCSI device management system.

SDRAM

Acronym for synchronous dynamic random-access memory.

sec

Abbreviation for second(s).

serial port

An I/O port used most often to connect a modem to your system. You can usually identify a serial port on your system by its 9-pin connector.

service tag number

A bar code label on the system that identifies it when you call Dell for customer or technical support.

SIMM

Acronym for single in-line memory module. A small circuit board containing DRAM chips that connects to the system board.

SMART

Acronym for Self-Monitoring Analysis and Reporting Technology. A technology that allows hard drives to report errors and failures to the system BIOS, which then displays an error message on the screen. To take advantage of this technology, you must have a SMART-compliant hard drive and the proper support in the system BIOS.

SMP

Abbreviation for symmetric multiprocessing. SMP is a system that has two or more microprocessors connected via a high-bandwidth link and managed by an operating system, where each microprocessor has equal access to I/O devices. This is in contrast to parallel processing, where a front-end microprocessor handles all I/O to disks, terminals, local area networks, and so on.

SNMP

Abbreviation for Simple Network Management Protocol. SNMP is an industry-standard interface that allows a network manager to remotely monitor and manage workstations.

SRAM

Abbreviation for static random-access memory. Because SRAM chips do not require continual refreshing, they are substantially faster than DRAM chips.

SVGA

Abbreviation for super video graphics array. VGA and SVGA are video standards for video adapters with greater resolution and color display capabilities than previous standards.

To display a program at a specific resolution, you must install the appropriate video drivers and your monitor must support the resolution. Similarly, the number of colors that a program can display depends on the capabilities of the monitor, the video driver, and the amount of video memory installed in the system.

system board

As the main circuit board, the system board usually contains most of your system's integral components, such as the following:

- Microprocessor
- RAM
- Controllers for standard peripheral devices, such as the keyboard
- Various ROM chips

Frequently used synonyms for system board are *motherboard* and *logic board*.

system configuration information

Data stored in memory that tells a system what hardware is installed and how the system should be configured for operation.

system diskette

System diskette is a synonym for *bootable diskette*.

system memory

System memory is a synonym for *RAM*.

System Setup program

A BIOS-based program that allows you to configure your system's hardware and customize the system's operation by setting such features as password protection and energy management. Some options in the System Setup program require that you reboot the system (or the system may reboot automatically) in order to make a hardware configuration change. Because the System Setup program is stored in NVRAM, any settings remain in effect until you change them again.

system.ini file

A start-up file for the Windows operating system. When you start Windows, it consults the **system.ini** file to determine a variety of options for the Windows operating environment. Among other things, the **system.ini** file records which video, mouse, and keyboard drivers are installed for Windows.

Running the Control Panel or Windows Setup program may change options in the **system.ini** file. On other occasions, you may need to change or add options to the **system.ini** file manually with a text editor, such as Notepad.

termination

Some devices (such as the last device at each end of a SCSI cable) must be terminated to prevent reflections and spurious signals in the cable. When such devices are connected in a series, you may need to enable or disable the termination on these devices by changing jumper or switch settings on the devices or by changing settings in the configuration software for the devices.

text mode

A video mode that can be defined as x columns by y rows of characters.

UL

Abbreviation for Underwriters Laboratories.

UMB

Abbreviation for upper memory blocks.

UNIX

Abbreviation for UNiversal Internet eXchange. UNIX, precursor to Linux, is an operating system written in the C programming language. Known for its portability and flexibility, UNIX has become a leading operating system for computer workstations.

upper memory area

The 384 KB of RAM located between 640 KB and 1 MB. If the system has an Intel386 or higher microprocessor, a utility called a *memory manager* can create UMBs in the upper memory area, in which you can load device drivers and memory-resident programs.

UPS

Abbreviation for uninterruptible power supply. A battery-powered unit that automatically supplies power to your system in the event of an electrical failure.

USB

Abbreviation for Universal Serial Bus. A USB connector provides a single connection point for multiple USB-compliant devices, such as mice, keyboards, printers, and system speakers. USB devices can also be connected and disconnected while the system is running.

utility

A program used to manage system resources—memory, disk drives, or printers, for example.

UTP

Abbreviation for unshielded twisted pair.

V

Abbreviation for volt(s).

VAC

Abbreviation for volt(s) alternating current.

VCCI

Abbreviation for Voluntary Control Council for Interference.

VDC

Abbreviation for volt(s) direct current.

VESA

Acronym for Video Electronics Standards Association.

VGA

Abbreviation for video graphics array. VGA and SVGA are video standards for video adapters with greater resolution and color display capabilities than previous standards.

To display a program at a specific resolution, you must install the appropriate video drivers and your monitor must support the resolution. Similarly, the number of colors that a program can display depends on the capabilities of the monitor, the video driver, and the amount of video memory installed for the video adapter.

VGA feature connector

On some systems with a built-in VGA video adapter, a VGA feature connector allows you to add an enhancement adapter, such as a video accelerator, to your system. A VGA feature connector can also be called a *VGA pass-through connector*.

video adapter

The logical circuitry that provides—in combination with the monitor—your system's video capabilities. A video adapter may support more or fewer features than a specific monitor offers. Typically, a video adapter comes with video drivers for displaying popular application programs and operating systems in a variety of video modes.

On some systems, a video adapter is integrated into the system board. Also available are many video adapter cards that plug into an expansion-card connector.

Video adapters often include memory separate from RAM on the system board. The amount of video memory, along with the adapter's video drivers, may affect the number of colors that can be simultaneously displayed. Video adapters can also include their own coprocessor for faster graphics rendering.

video driver

A program that allows graphics-mode application programs and operating systems to display at a chosen resolution with the desired number of colors. A software package may include some "generic" video drivers. Any additional video drivers may need to match the video adapter installed in the system.

video memory

Most VGA and SVGA video adapters include memory chips in addition to your system's RAM. The amount of video memory installed primarily influences the number of colors that a program can display (with the appropriate video drivers and monitor capabilities).

video mode

Video adapters normally support multiple text and graphics display modes. Character-based software displays in text modes that can be defined as x columns by y rows of characters. Graphics-based software displays in graphics modes that can be defined as x horizontal by y vertical pixels by z colors.

video resolution

Video resolution—800 x 600, for example—is expressed as the number of pixels across by the number of pixels up and down. To display a program at a specific graphics resolution, you must install the appropriate video drivers and your monitor must support the resolution.

VRAM

Abbreviation for video random-access memory. Some video adapters use VRAM chips (or a combination of VRAM and DRAM) to improve video performance. VRAM is dual-ported, allowing the video adapter to update the screen and receive new image data at the same time.

W

Abbreviation for watt(s).

WH

Abbreviation for watt-hour(s).

win.ini file

A start-up file for the Windows operating system. When you start Windows, it consults the **win.ini** file to determine a variety of options for the Windows operating environment. Among other things, the **win.ini** file records what printer(s) and fonts are installed for Windows. The win.ini file also usually includes sections that contain optional settings for Windows application programs that are installed on the hard drive.

Running the Control Panel or Windows Setup program may change options in the **win.ini** file. On other occasions, you may need to change or add options to the **win.ini** file manually with a text editor such as Notepad.

Windows 2000

An integrated and complete Microsoft Windows operating system that does not require MS-DOS and that provides advanced operating system performance, improved ease of use, enhanced workgroup functionality, and simplified file management and browsing.

Windows NT

High-performance server and workstation operating system software developed by Microsoft that is intended for technical, engineering, and financial applications.

Windows Powered

A Windows operating system designed for use on devices and appliances. For NAS systems, the Windows Powered operating system is dedicated to file service for network clients.

write-protected

Read-only files are said to be *write-protected*. You can write-protect a 3.5-inch diskette by sliding its write-protect tab to the open position or by setting the write-protect feature in the System Setup program.

[Back to Contents Page](#)